

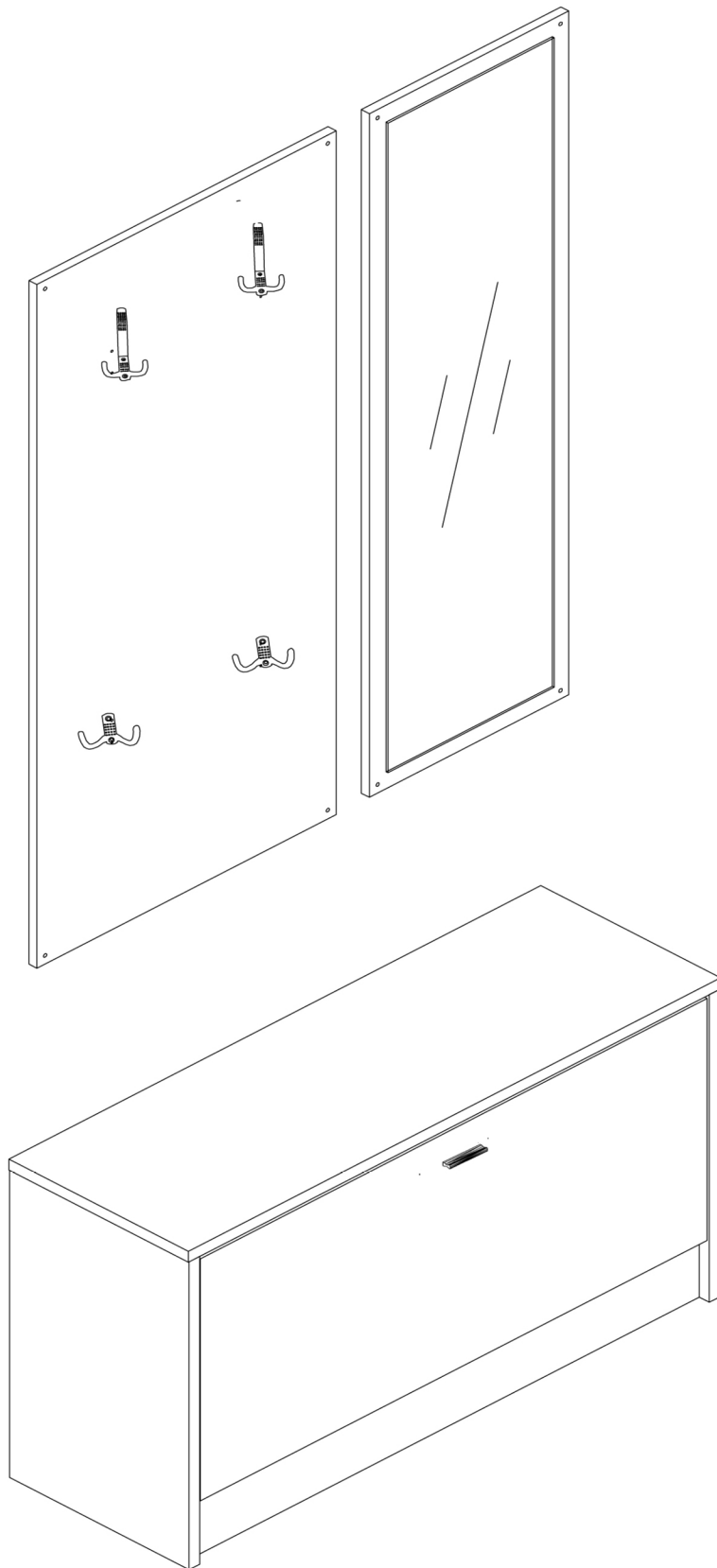



















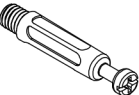

THOMAS

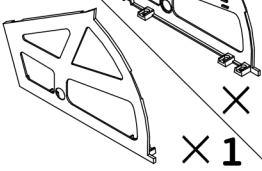
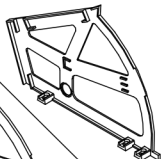
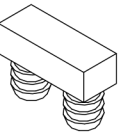
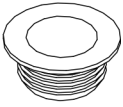

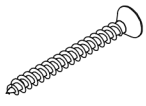
1		1000*450*12=1	8		450*270*16=1
2		1000*300*16=1	9		757*140*12=2
3		800*270*16=1	10		757*88*12=1
4		762*354*12=1	11		776*380*3=1
5		766*80*16=1			
6		766*80*16=1			
7		450*270*16=1			

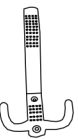
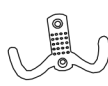
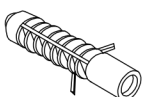
A  × 12	B  × 12	C  × 1	D  4*16mm × 2	E1  × 1	E2  × 1
F  × 2	G  × 2	H  × 2	I  3.5*40mm × 8	J  4*14mm × 18	
K  × 2	L  × 2	M  × 8	N  × 8	O  × 6	

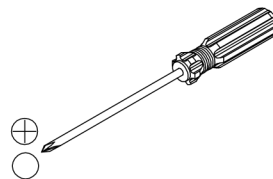
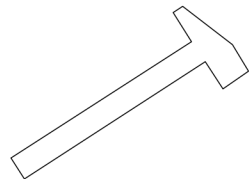
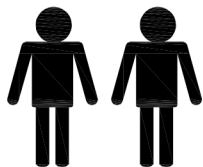

1

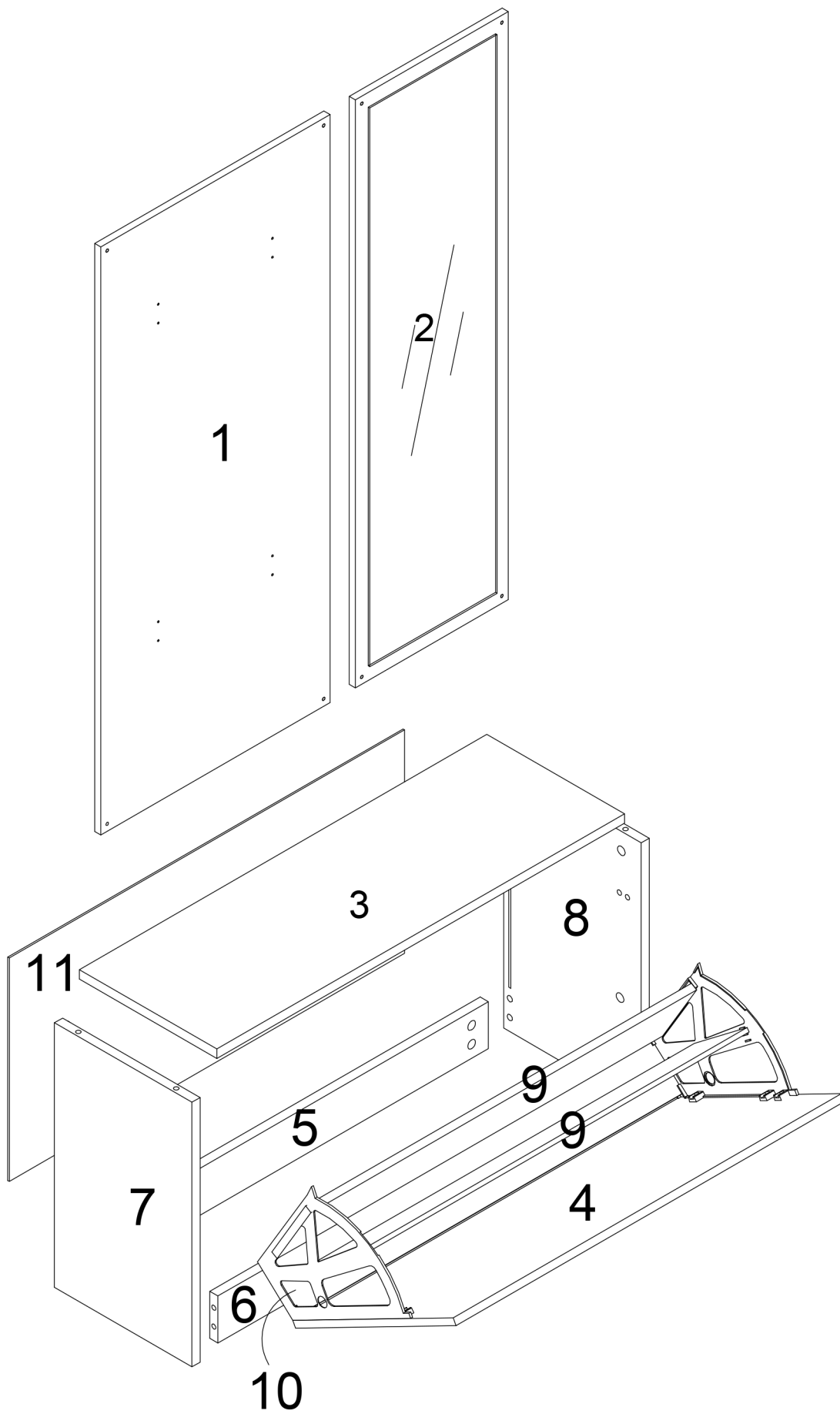

2

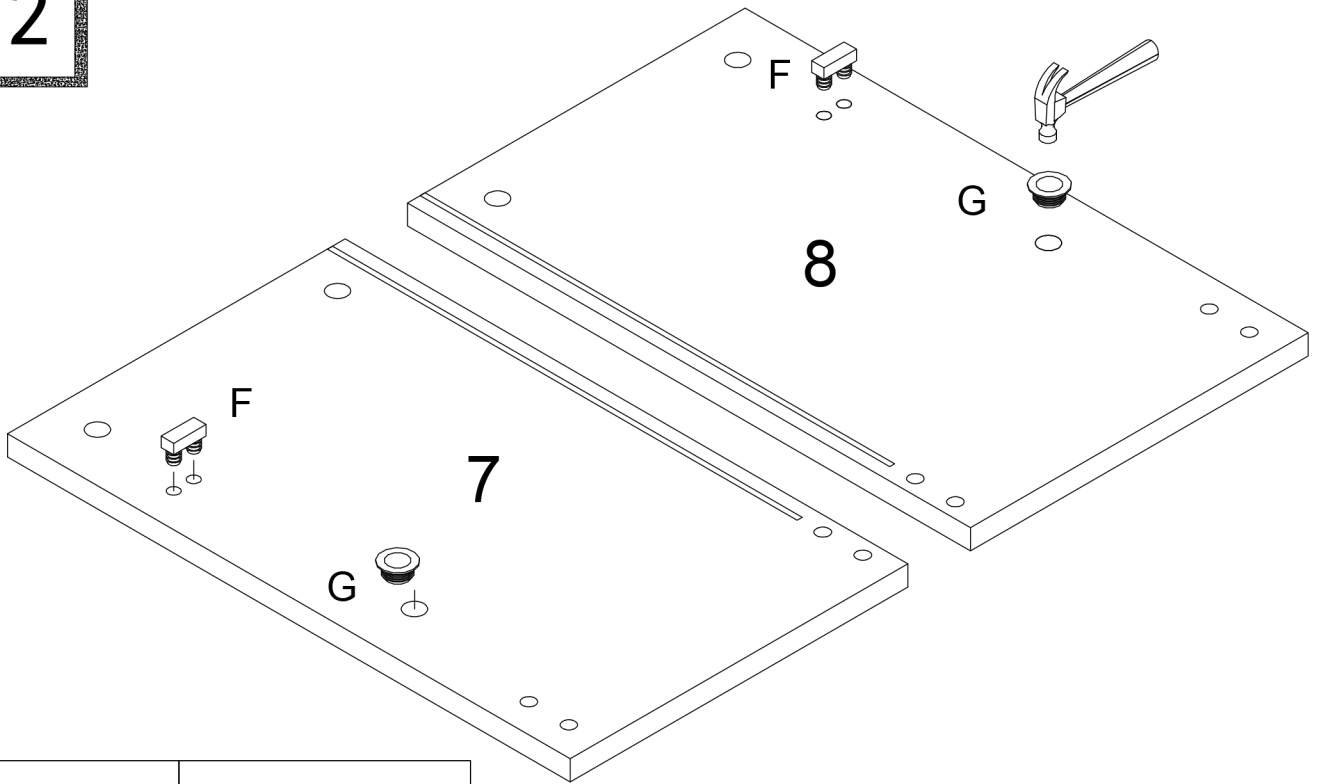

F 2 PCS



G 2 PCS



3

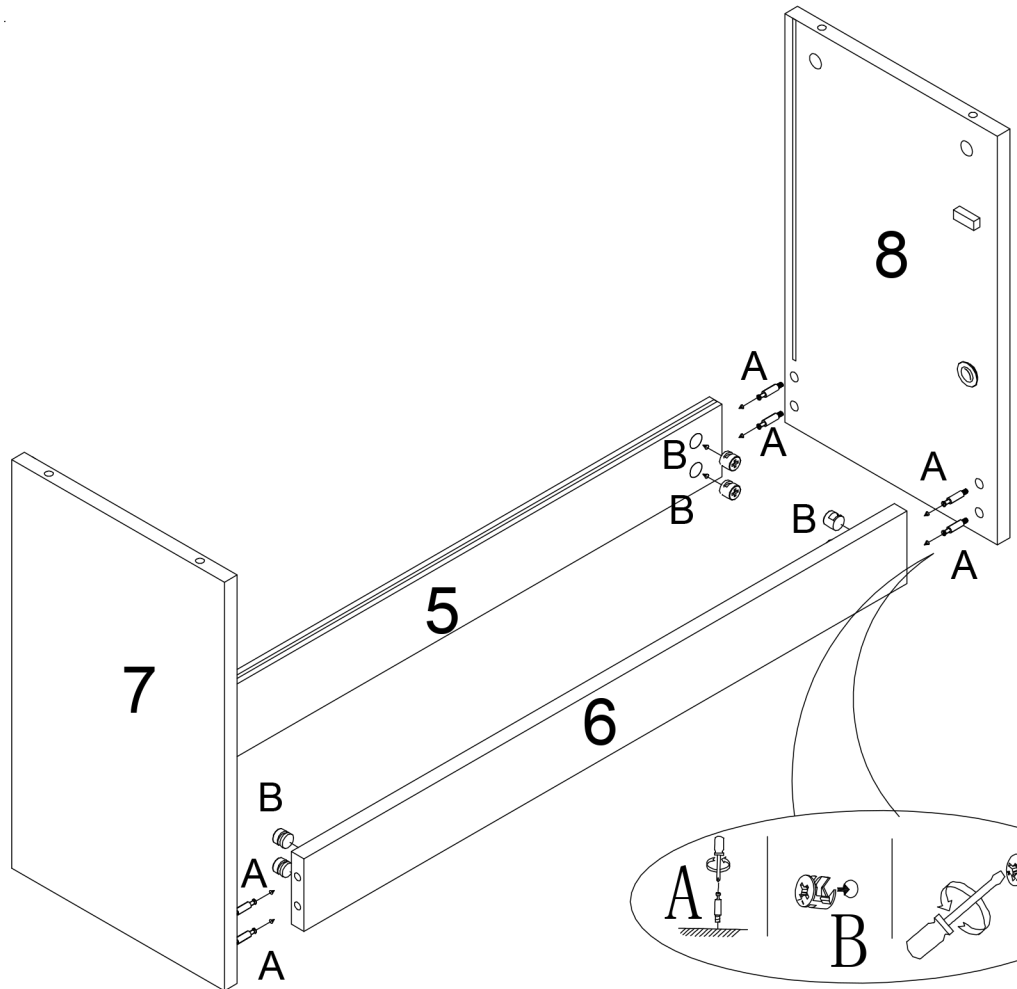

A 8 PCS

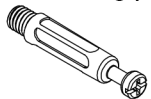

B 8 PCS



3

4

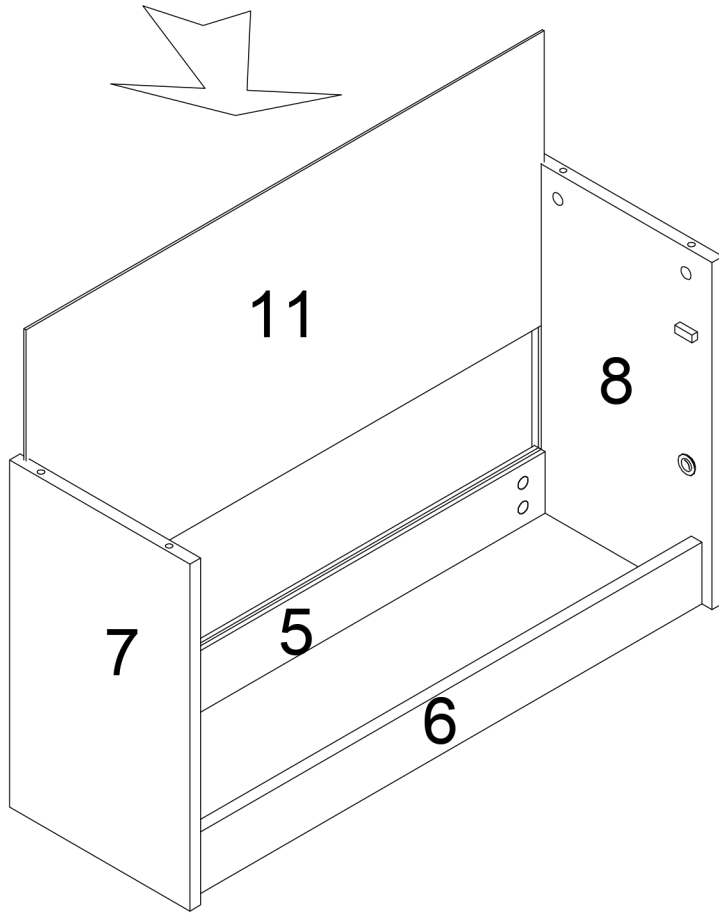

5

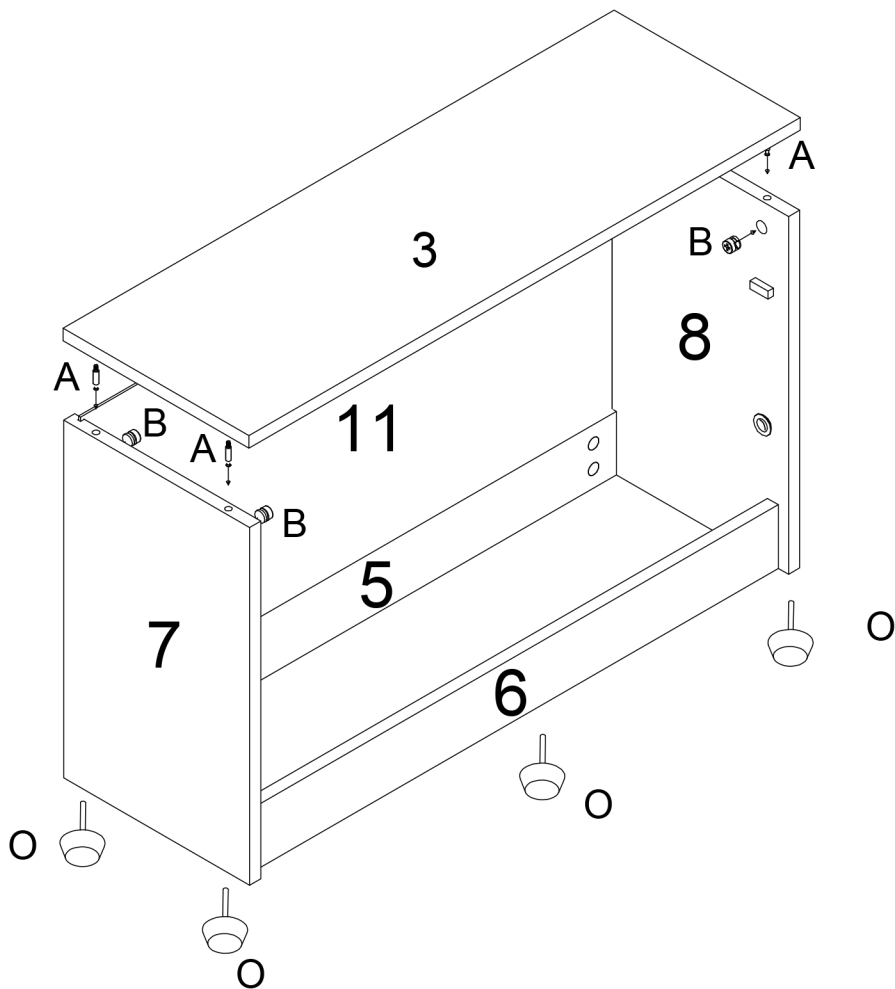

O 6 PCS





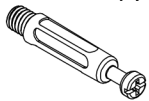

A 4 PCS

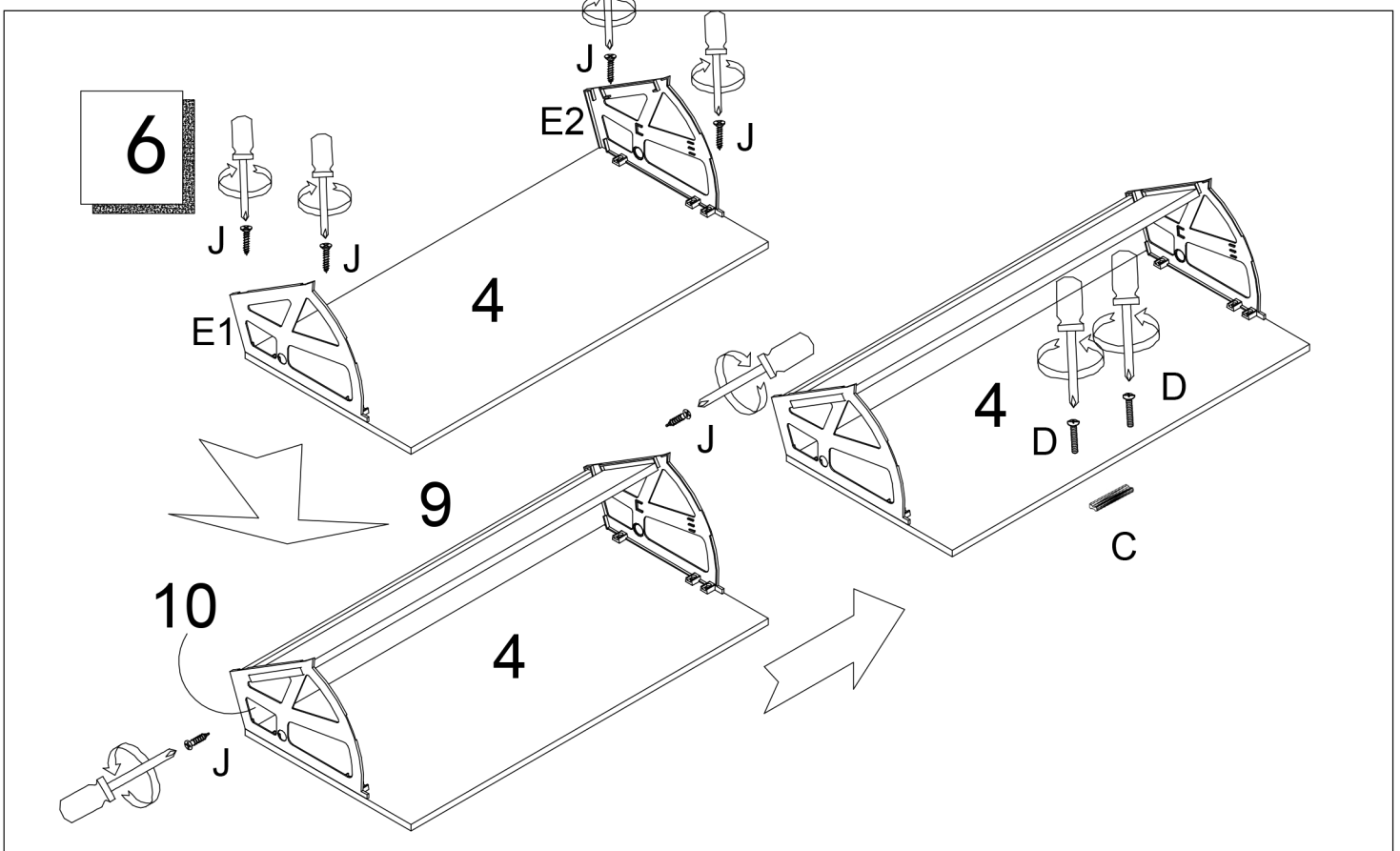

B 4 PCS



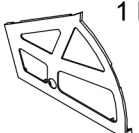
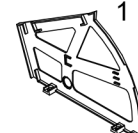

<p>C 1 PCS</p> 	<p>D 2 PCS</p> 	<p>E1 1 PCS</p> 	<p>E2 1 PCS</p> 	<p>J 6 PCS</p> 
-----------------------------------------------------------------------------------------------------------	-----------------------------------------------------------------------------------------------------------	-----------------------------------------------------------------------------------------------------------	------------------------------------------------------------------------------------------------------------	-------------------------------------------------------------------------------------------------------------

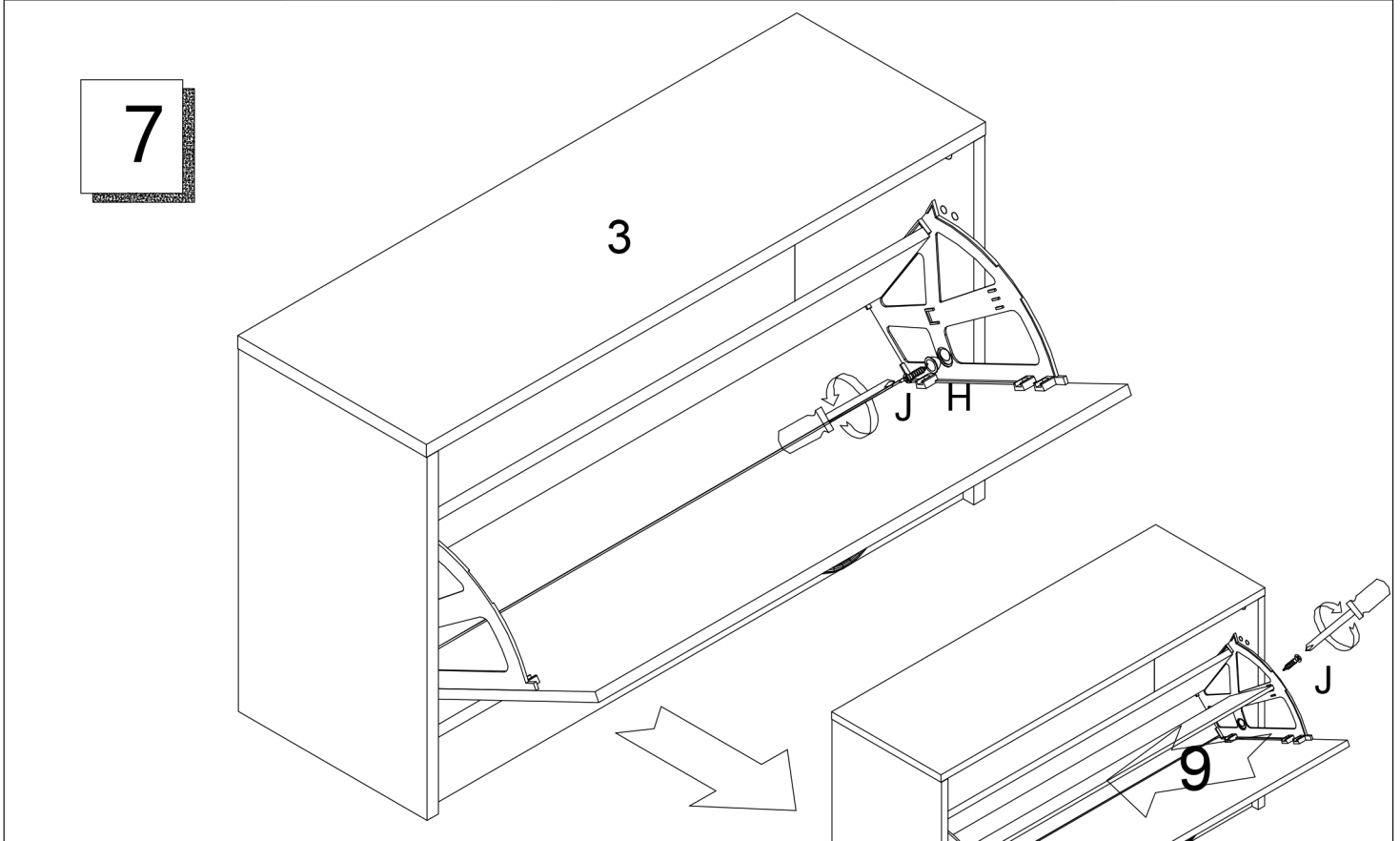

<p>H 2 PCS</p> 	<p>J 2 PCS</p> 	<p>J 2 PCS</p> <p>5</p> 
-----------------------------------------------------------------------------------------------------------	-----------------------------------------------------------------------------------------------------------	-----------------------------------------------------------------------------------------------------------------------------

8

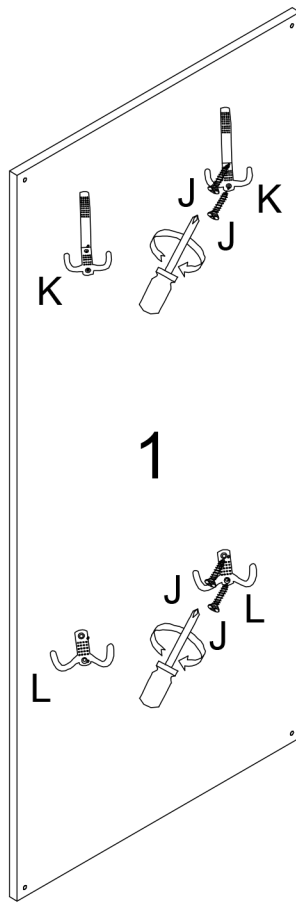

K 2 PCS



L 2 PCS



J 8 PCS



9

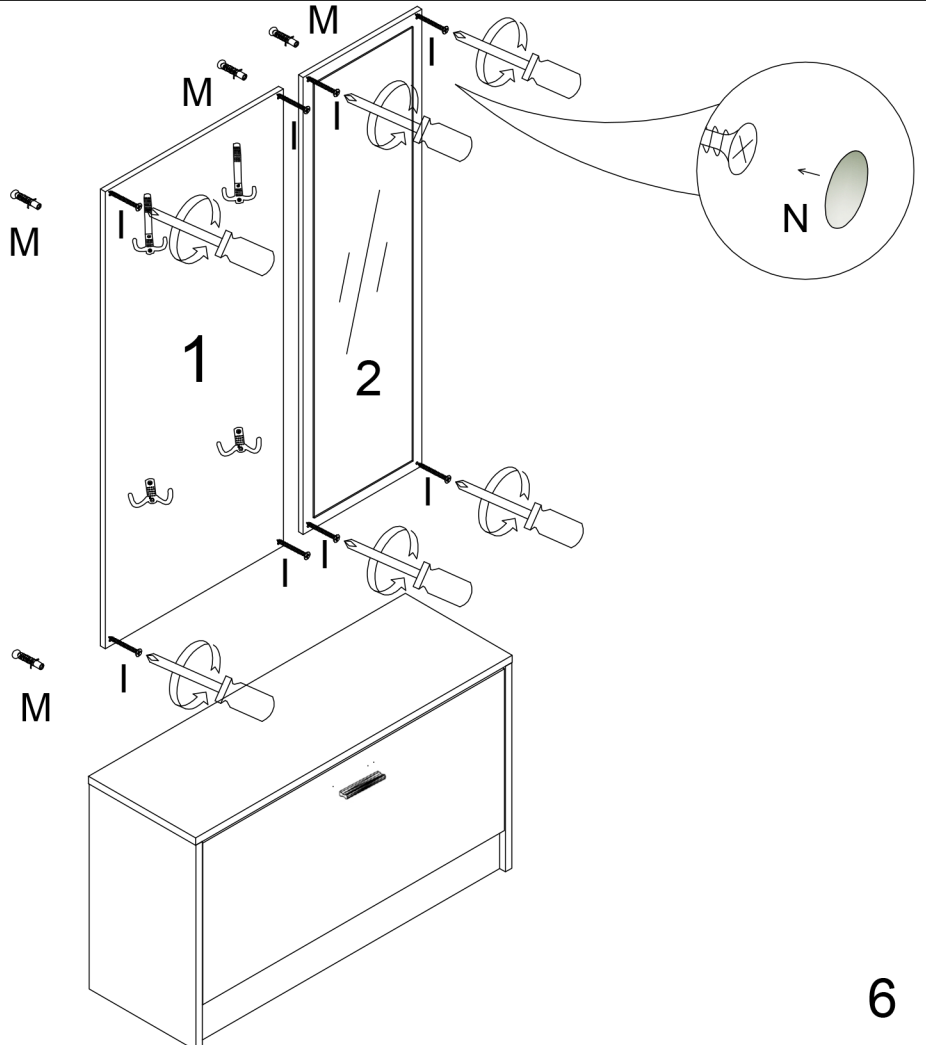

M 8 PCS



I 8 PCS



N 8 PCS



6