

# 1

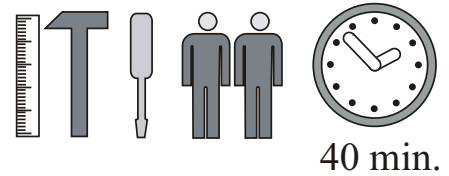

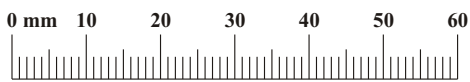

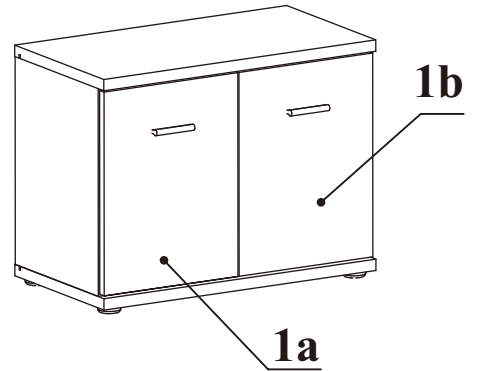

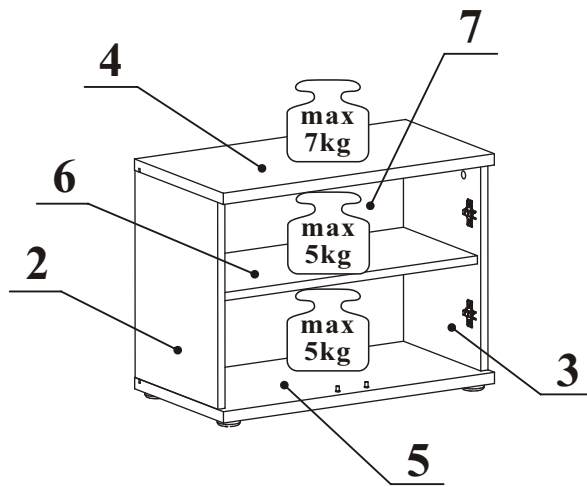
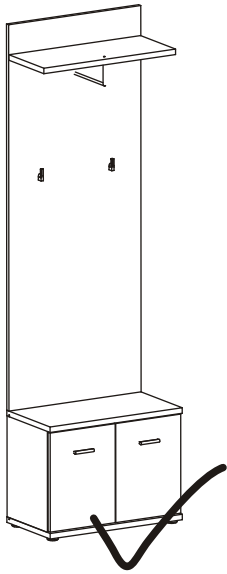

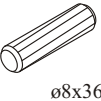

# ARMARIO 1

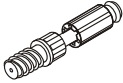
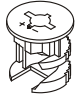
# (type-F)

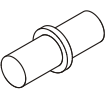
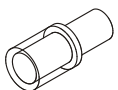
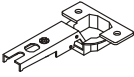
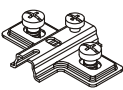
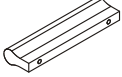
# 24 DSAR-F

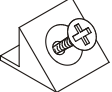
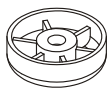

40 min.

A1 X8  ø8x36	B11 X4  Ø7x50	G4 X4 	B4 X4 	B5 X4  ø15x12	G5 X4 
G7 X4 	G20 X2 	E1 X4  H=0	E2 X4  H=0	KL X2 	UP6 X4  UPØ4x30
Z2 X4  ø5	S1 X6 	I11 X4 	D10 X8  USØ3,5x13	D11 X4  USØ3,5x25	G2 X1 

# ARMARIO 1

(type-F)

24 DSAR-F

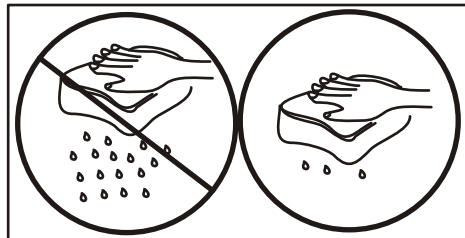
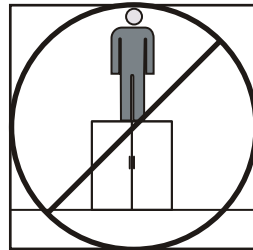
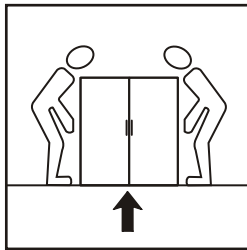
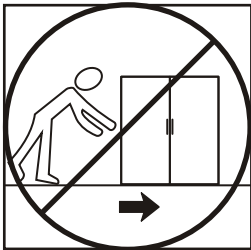
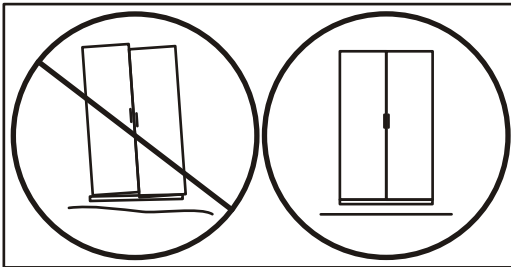
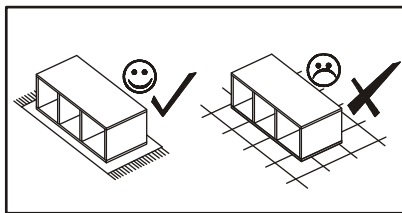
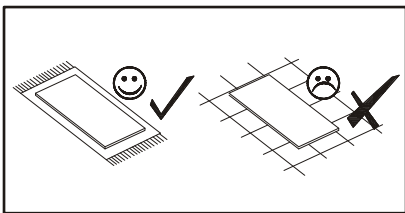
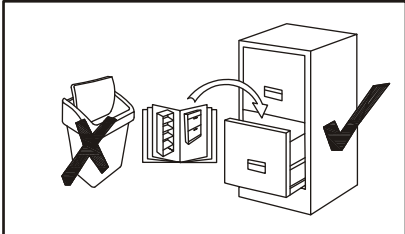
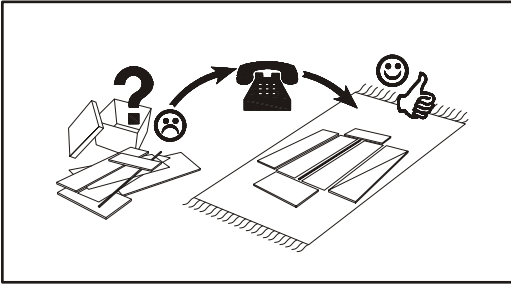

# ARMARIO 1

(type-F)

# 24 DSAR-F

## 1

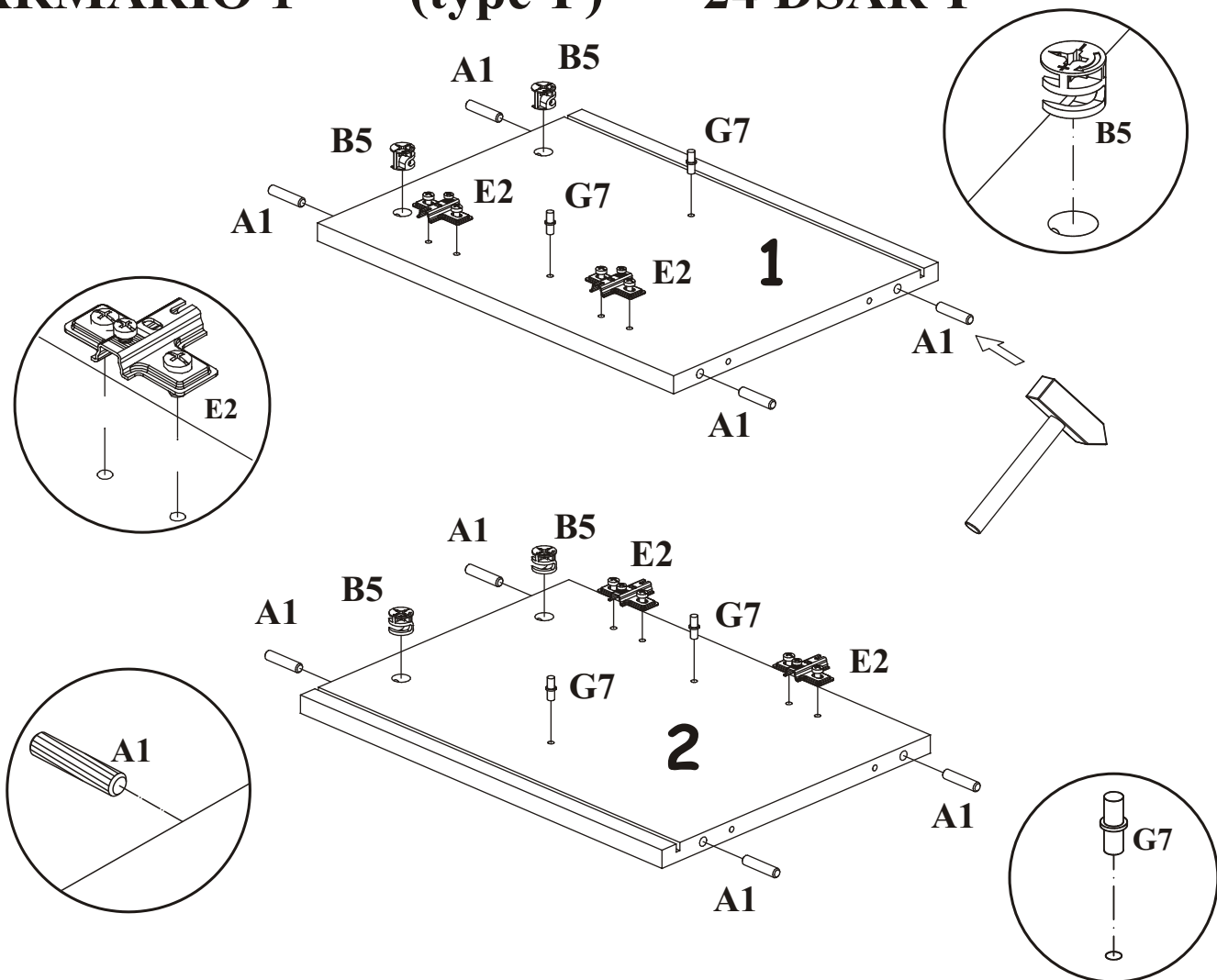

## 2

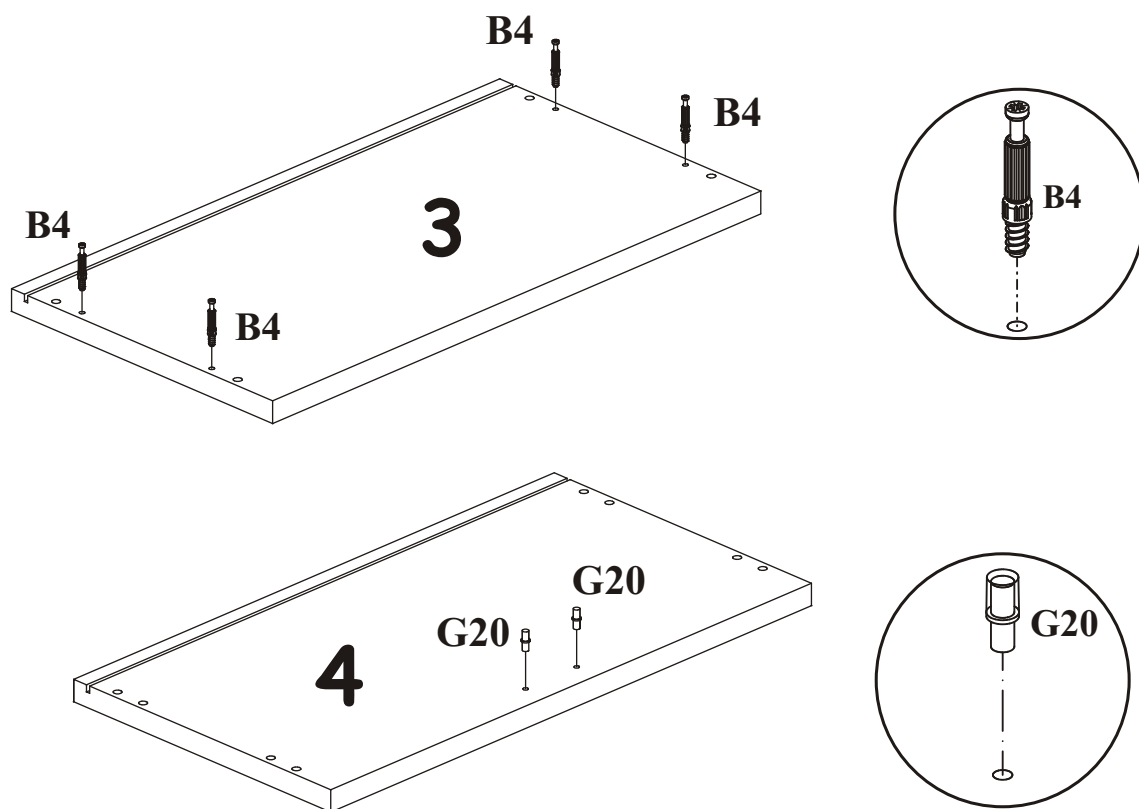

# ARMARIO 1

(type-F)

24 DSAR-F

3

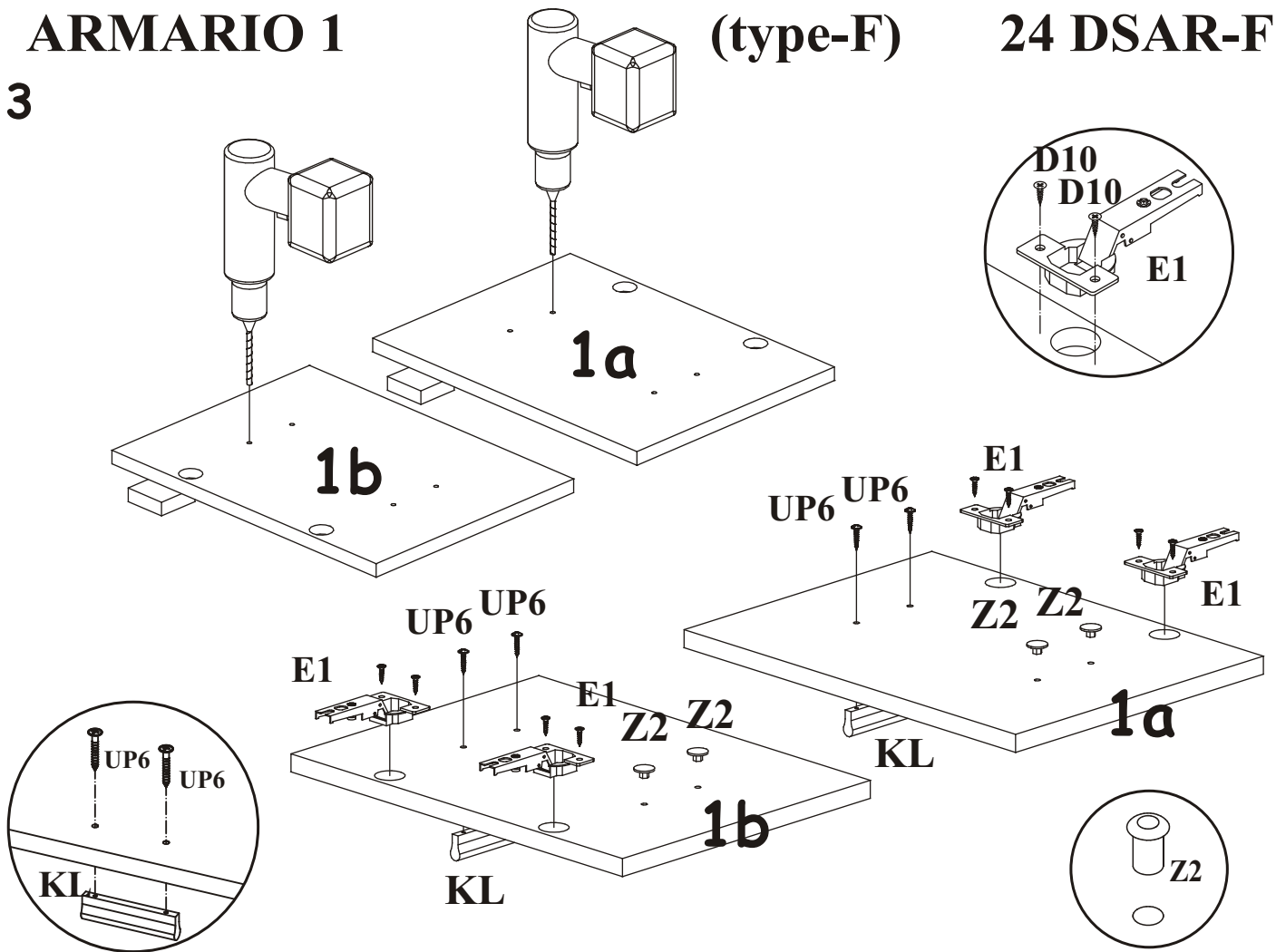

4

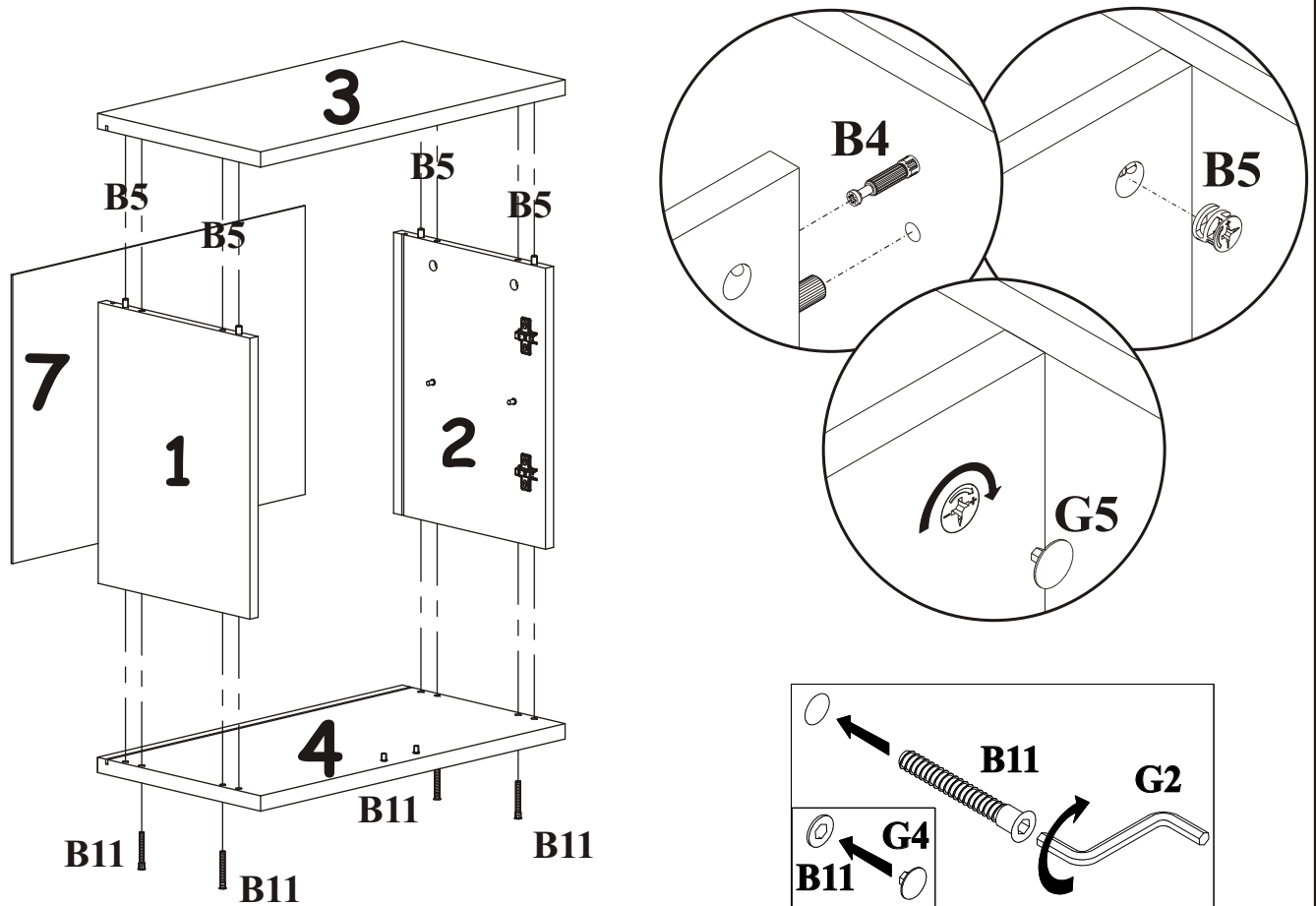

# ARMARIO 1

(type-F)

# 24 DSAR-F

## 5

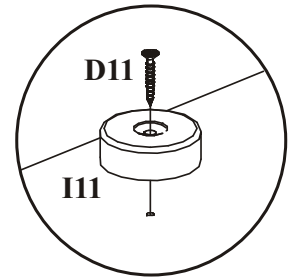
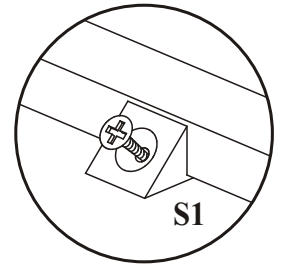
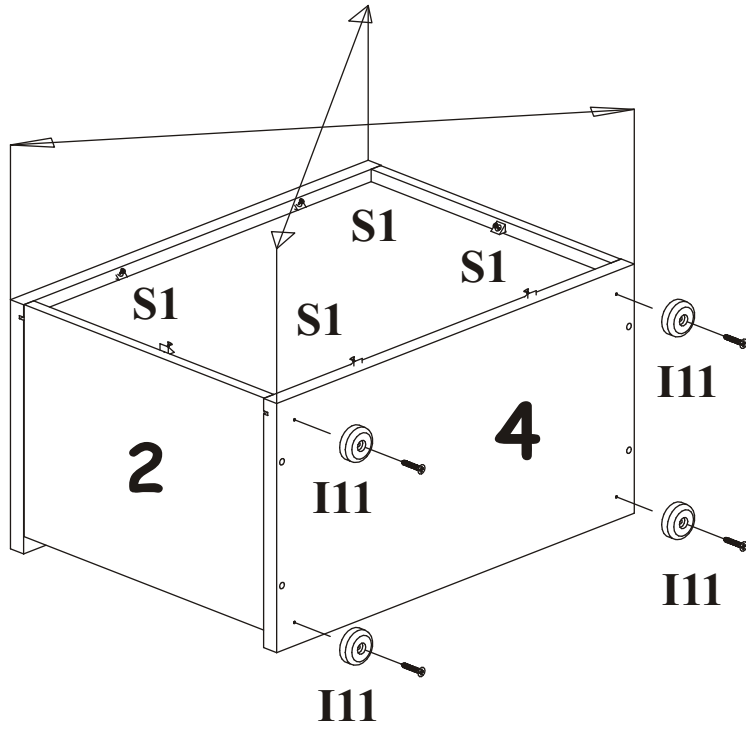

## 6

